

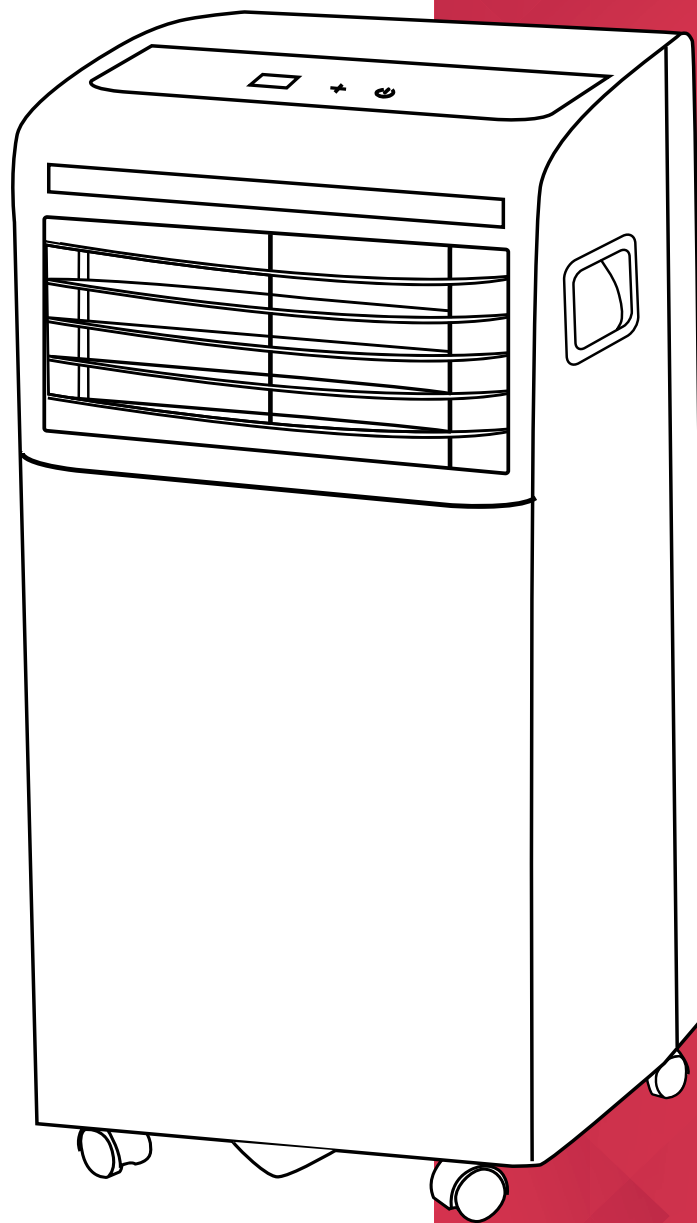

INSTRUCTION MANUAL



Portable Air Conditioner

Model: DCP7W

For domestic household use only.



IMPORTANT

THESE INSTRUCTIONS SHOULD BE READ CAREFULLY AND RETAINED FOR FUTURE REFERENCE.

Note also the information presented on the appliance

CAUTION: FAILURE TO FOLLOW THESE INSTRUCTIONS MAY CAUSE INJURY AND/OR DAMAGE AND MAY INVALIDATE YOUR WARRANTY

Please read the operating instructions carefully before using your Portable Air Conditioner for the first time and keep them in a safe place.

WARNING - This appliance must not be used in a bathroom.

WARNING - Do not use this appliance in the immediate surroundings of a bath, a shower or a swimming pool.

- Installation must be performed according to the installation instructions. Improper installation can cause water leakage, electrical shock, or fire.
- If the mains lead is damaged it must only be replaced by the manufacturers service agent or a similarly qualified person in order to avoid a hazard.
- This appliance is not intended for use by persons (including children) with reduced physical, sensory or mental capabilities, or lack of experience and knowledge, unless they have been given supervision or instruction concerning use of the appliance by a person responsible for their safety.
- Children should be supervised to ensure they do not play with the appliance.
- Prior to cleaning or other maintenance, the appliance must be disconnected from the supply mains.
- Never immerse the appliance in water or other liquids.
- Operate this unit only on a firm, flat surface to avoid the risk of water leakage. Ensure that the unit is kept upright at all times.
- Do not place on soft, unstable or non-horizontal/angled surfaces.
- Never operate the appliance if a cable or connector has been damaged, after appliance malfunction or if the appliance was dropped or is otherwise damaged.
- Please ask a professional service agent to repair the product. Improper repair may cause danger to users.
- Disconnect the appliance from mains power whenever it is not in use, before relocating it, and before cleaning.
- Operate the appliance only at the voltage specified on the rating label on the unit.
- Only connect the unit to a properly installed and easily accessible socket so that you can quickly disconnect the plug if necessary.
- Do not connect this product to the mains using an extension lead.
- Never use the mains lead as a carrying strap or pulling lead.
- This product is only intended for INDOOR RESIDENTIAL applications. This product should not be used for commercial or industrial or leisure applications or in small enclosed spaces.
- To avoid a fire or electrocution hazard, NEVER put the cord near heat registers, radiator, stoves or heaters.
- DO NOT cover cord with carpeting, throw rugs, runners, or similar coverings.
- DO NOT route cord under furniture or appliances. Take care to position the cord away from traffic areas and where it will not be a tripping hazard.
- DO NOT use the unit near windows or where water collects. Rain and water collection may lead to a risk of fire or electric shock.
- Only operate this appliance with a minimum of 50cm clearance all around i.e. away from walls, furniture and overhanging objects such as curtains or a shelf.

- **WARNING:** To avoid danger of suffocation please remove all packaging materials particularly plastic and EPS and keep these away from vulnerable people, children and babies.
- NEVER drop or insert any object or fingers into any openings.
- Do not cover or obstruct the air inlet and outlets.
- Do not use the appliance in locations where paint, petrol or other flammable liquids are used or stored near appliances with continuously operating open flames.
- Do not use bug sprays or other flammable cleansers/vapour sprays on or around the unit.
- Always switch off the unit and take the plug out of the socket:
 - If you are not using the unit
 - Before you clean or carry out maintenance on the unit
 - If a fault occurs
 - In the event of an electrical storm.
- Avoid electromagnetic interference. Keep the unit at least 1 metre away from electrical appliances such as televisions & radios.
- The air conditioner must always be stored and transported upright. In case of doubt we suggest you wait for at least 24 hours before operation. (Please keep unit upright at all times).
- This portable air conditioner is fitted with a compressor delay protection circuit. This protects the unit from possible damage due to rapid starting and stopping of its compressor. The compressor will begin operation 3 minutes after the unit has been switched ON or if the mode is changed from dehumidify to cooling.
- It is hazardous for anyone other than an Authorised Service Person to service this appliance. In Queensland - the authorised Service Person MUST hold a Gas Work Authorisation for hydrocarbon refrigerants to carry out servicing or repairs where the gas system is being opened or charged.
- The appliance shall be installed in accordance with national wiring regulations.



WARNING: For using R290 refrigerant. This symbol shows that this appliance uses a flammable refrigerant. If the refrigerant is leaked and exposed to an external ignition source, there is a risk of fire.

CAUTION: RISK OF FIRE/FLAMMABLE MATERIALS. THE APPLIANCE MUST BE INSTALLED, USED & STORED IN AN AREA THAT IS GREATER THAN 8m².



NB: These symbols on your device mean:

- This appliance is filled with Propane gas R290. Follow strictly the manufacturer's instruction concerning use and repairs!
- Before using this appliance, you must carefully read the entire instruction manual.
- This appliance contains a small quantity of R290 refrigerant which is environmentally friendly, but flammable. It does not damage the ozone layer, nor does it increase the greenhouse effect.
- It is hazardous for anyone other than an Authorised Service Person to service this appliance. In Queensland - the authorised Service Person MUST hold a Gas Work Authorisation for hydrocarbon refrigerants to carry out servicing or repairs where the gas system is being opened or charged.
- Do not install, operate or store the device in a room with a floor area smaller than 8m².
- Repairs must be performed based on the recommendations from the manufacturing company.
- Note also the information presented on the appliance.
- Do not use means to accelerate the defrosting process or to clean, other than those recommended by the manufacturer.
- The appliance shall NOT be stored in a room with continuously operating ignition sources (for example: open flames, an operating gas appliance or an operating electric heater).
- Do not pierce or burn.
- Be aware that the refrigerants may not contain an odour.
- The appliance should be installed, operated and stored in a room with a floor area according to the amount of refrigerant to be charged. For specific information on the type of gas and the amount, please refer to the relevant label on the unit itself. When there are differences between the label and the manual on the Min. room area description, the description on label shall prevail.
- Compliance with national gas regulations shall be observed.
- Keep ventilation openings clear of obstruction.
- The appliance shall be stored so as to prevent mechanical damage from occurring.
- A warning that the appliance shall be stored in a well-ventilated area where the room size corresponds to the room area as specified for operation.
- Any person who is involved with working on or breaking into a refrigerant circuit should hold a current valid certificate from an industry-accredited assessment authority, which authorises their competence to handle refrigerants safely in accordance with an industry recognised assessment specification.

- Servicing shall only be performed as recommended by the equipment manufacturer. Maintenance and repair requiring the assistance of other skilled personnel shall be carried out under the supervision of the person competent in the use of flammable refrigerants.
 - Please follow the instruction carefully to handle, install, clear, service the air conditioner to avoid any damage or hazard. When maintaining or disposing the air conditioner, the refrigerant (R290) shall be recovered properly, shall not discharge to air directly.
 - No any open fire or device like switch which may generate sparking shall be around the air conditioner to avoid causing ignition of the flammable refrigerant used.
1. Transport of equipment containing flammable refrigerants - see transport regulations.
 2. Marking of equipment using signs - see local regulations.
 3. Disposal of equipment using flammable refrigerants - see national regulations.
 4. Storage of equipment/appliances - The storage of equipment should be in accordance with the manufacturer's instructions.
 5. Storage of packed (unsold) equipment - storage package protection should be constructed such that mechanical damage to the equipment inside the package will not cause a leak of the refrigerant. The maximum number of pieces of equipment permitted to be stored together will be determined by local regulations.
 6. Information on servicing:
 - Checks to the area
Prior to beginning work on systems containing flammable refrigerants, safety checks are necessary to ensure that the risk of ignition is minimised. For repair to the refrigerating system, the following precautions shall be complied with prior to conducting work on the system.
 - Work procedure
Work shall be undertaken under a controlled procedure so as to minimise the risk of a flammable gas or vapour being present while the work is being performed.
 - General work area
All maintenance staff and others working in the local area shall be instructed on the nature of work being carried out. Work in confined spaces shall be avoided. The area around the workspace shall be sectioned off. Ensure that the conditions within the area have been made safe by control of flammable material.
 - Checking for presence of refrigerant
The area shall be checked with an appropriate refrigerant detector prior to and during work, to ensure the technician is aware of potentially flammable atmospheres. Ensure that the leak detection equipment being used is suitable for use with flammable refrigerants, i.e. non-sparking, adequately sealed or intrinsically safe.
 - Presence of fire extinguisher
If any hot work is to be conducted on the refrigeration equipment or any associated parts, appropriate fire extinguishing equipment shall be available to hand. Have a dry powder or CO2 fire extinguisher adjacent to the charging area.
 - No ignition sources
No person carrying out work in relation to a refrigeration system which involves exposing any pipe work that contains or has contained flammable refrigerant shall use any sources of ignition in such a manner that it may lead to the risk of fire or explosion. All possible ignition sources, including cigarette smoking, should be kept sufficiently far away from the site of installation, repairing, removing and disposal, during which flammable refrigerant can possibly be released to the surrounding space. Prior to work taking place, the area around the equipment is to be surveyed to make sure that there are no flammable hazards or ignition risks. No Smoking signs shall be displayed.
 - Ventilated area
Ensure that the area is in the open or that it is adequately ventilated before breaking into the system or conducting any hot work. A degree of ventilation shall continue during the period that the work is carried out. The ventilation should safely disperse any released refrigerant and preferably expel it externally into the atmosphere.

- **Checks to the refrigeration equipment**

Where electrical components are being changed, they shall be fit for the purpose and to the correct specification. At all times the manufacturer's maintenance and service guidelines shall be followed. If in doubt consult the manufacturer's technical department for assistance. The following checks shall be applied to installations using flammable refrigerants:

The charge size is in accordance with the room size within which the refrigerant containing parts are installed;

The ventilation machinery and outlets are operating adequately and are not obstructed; If an indirect refrigerating circuit is being used, the secondary circuit shall be checked for the presence of refrigerant;

Marking to the equipment continues to be visible and legible. Markings and signs that are illegible shall be corrected;

Refrigeration pipe or components are installed in a position where they are unlikely to be exposed to any substance which may corrode refrigerant containing components, unless the components are constructed of materials which are inherently resistant to being corroded or are suitably protected against being so corroded.

- **Checks to electrical devices**

Repair and maintenance to electrical components shall include initial safety checks and component inspection procedures. If a fault exists that could compromise safety, then no electrical supply shall be connected to the circuit until it is satisfactorily dealt with. If the fault cannot be corrected immediately but it is necessary to continue operation, an adequate temporary solution shall be used. This shall be reported to the owner of the equipment so all parties are advised.

Initial safety checks shall include:

That capacitors are discharged: this shall be done in a safe manner to avoid possibility of sparking; That there no live electrical components and wiring are exposed while charging, recovering or purging the system; That there is continuity of earth bonding.

- **Repairs to sealed components**

During repairs to sealed components, all electrical supplies shall be disconnected from the equipment being worked upon prior to any removal of sealed covers, etc. If it is absolutely necessary to have an electrical supply to equipment during servicing, then a permanently operating form of leak detection shall be located at the most critical point to warn of a potentially hazardous situation.

Particular attention shall be paid to the following to ensure that by working on electrical components, the casing is not altered in such a way that the level of protection is affected. This shall include damage to cables, excessive number of connections, terminals not made to original specification, damage to seals, incorrect fitting of glands, etc. Ensure that apparatus is mounted securely. Ensure that seals or sealing materials have not degraded such that they no longer serve the purpose of preventing the ingress of flammable atmospheres. Replacement parts shall be in accordance with the manufacturer's specifications.

NOTE: The use of silicon sealant may inhibit the effectiveness of some types of leak detection equipment. Intrinsically safe components do not have to be isolated prior to working on them.

- **Repair to intrinsically safe components**

Do not apply any permanent inductive or capacitance loads to the circuit without ensuring that this will not exceed the permissible voltage and current permitted for the equipment in use. Intrinsically safe components are the only types that can be worked on while live in the presence of a flammable atmosphere. The test apparatus shall be at the correct rating. Replace components only with parts specified by the manufacturer. Other parts may result in the ignition of refrigerant in the atmosphere from a leak.

- **Cabling**

Check that cabling will not be subject to wear, corrosion, excessive pressure, vibration, sharp edges or any other adverse environmental effects. The check shall also take into account the effects of aging or continual vibration from sources such as compressors or fans.

- **Detection of flammable refrigerants**

Under no circumstances shall potential sources of ignition be used in the searching for or detection of refrigerant leaks. A halide torch (or any other detector using a naked flame) shall not be used.

- **Leak detection methods**

The following leak detection methods are deemed acceptable for systems containing flammable refrigerants. Electronic leak detectors shall be used to detect flammable refrigerants, but the sensitivity may not be adequate, or may need re-calibration. (Detection equipment shall be calibrated in a refrigerant-free area.) Ensure that the detector is not a potential source of ignition and is suitable for the refrigerant used. Leak detection equipment shall be set at a percentage of the LFL of the refrigerant and shall be calibrated to the refrigerant employed and the appropriate percentage of gas (25 % maximum) is confirmed. Leak detection fluids are suitable for use with most refrigerants but the use of detergents containing chlorine shall be avoided as the chlorine may react with the refrigerant and corrode the copper pipe-work. If a leak is suspected, all naked flames shall be removed/ extinguished. If a leakage of refrigerant is found which requires brazing, all of the refrigerant shall be recovered from the system, or isolated (by means of shut off valves) in a part of the system remote from the leak. Oxygen free nitrogen (OFN) shall then be purged through the system both before and during the brazing process.

- **Removal and evacuation**

When breaking into the refrigerant circuit to make repairs or for any other purpose conventional procedures shall be used. However, it is important that best practice is followed since flammability is a consideration. The following procedure shall be adhered to: Remove refrigerant; Purge the circuit with inert gas; Evacuate; Purge again with inert gas; Open the circuit by cutting or brazing.

The refrigerant charge shall be recovered into the correct recovery cylinders. The system shall be flushed with OFN to render the unit safe. This process may need to be repeated several times. Compressed air or oxygen shall not be used for this task. Flushing shall be achieved by breaking the vacuum in the system with OFN and continuing to fill until the working pressure is achieved, then venting to atmosphere, and finally pulling down to a vacuum. This process shall be repeated until no refrigerant is within the system. When the final OFN charge is used, the system shall be vented down to atmospheric pressure to enable work to take place. This operation is absolutely vital if brazing operations on the pipe-work are to take place. Ensure that the outlet for the vacuum pump is not close to any ignition sources and there is ventilation available.

- **Charging procedures**

In addition to conventional charging procedures, the following requirements shall be followed. Ensure that contamination of different refrigerants does not occur when using charging equipment. Hoses or lines shall be as short as possible to minimise the amount of refrigerant contained in them.

Cylinders shall be kept upright.

Ensure that the refrigeration system is earthed prior to charging the system with refrigerant.

Label the system when charging is complete (if not already).

Extreme care shall be taken not to overfill the refrigeration system. Prior to recharging the system it shall be pressure tested with OFN. The system shall be leak tested on completion of charging but prior to commissioning. A follow up leak test shall be carried out prior to leaving the site.

- **Decommissioning**

Before carrying out this procedure, it is essential that the technician is completely familiar with the equipment and all its detail. It is recommended good practice that all refrigerants are recovered safely. Prior to the task being carried out, an oil and refrigerant sample shall be taken in case analysis is required prior to re-use of reclaimed refrigerant. It is essential that electrical power is available before the task is commenced.

- a) Become familiar with the equipment and its operation.
- b) Isolate system electrically.
- c) Before attempting the procedure ensure that: Mechanical handling equipment is available, if required, for handling refrigerant cylinders; All personal protective equipment is available and being used correctly; The recovery process is supervised at all times by a competent person; Recovery equipment and cylinders conform to the appropriate standards.
- d) Pump down refrigerant system, if possible.
- e) If a vacuum is not possible, make a manifold so that refrigerant can be removed from various parts of the system.
- f) Make sure that cylinder is situated on the scales before recovery takes place.
- g) Start the recovery machine and operate in accordance with manufacturer's instructions.
- h) Do not overfill cylinders. (No more than 80 % volume liquid charge).
- i) Do not exceed the maximum working pressure of the cylinder, even temporarily.
- j) When the cylinders have been filled correctly and the process completed, make sure that the cylinders and the equipment are removed from site promptly and all isolation valves on the equipment are closed off.
- k) Recovered refrigerant shall not be charged into another refrigeration system unless it has been cleaned and checked.

- **Labelling**

Equipment shall be labelled stating that it has been de-commissioned and emptied of refrigerant. The label shall be dated and signed. Ensure that there are labels on the equipment stating the equipment contains flammable refrigerant.

- **Recovery**

When removing refrigerant from a system, either for servicing or decommissioning, it is recommended good practice that all refrigerants are removed safely. When transferring refrigerant into cylinders, ensure that only appropriate refrigerant recovery cylinders are employed. Ensure that the correct number of cylinders for holding the total system charge is available. All cylinders to be used are designated for the recovered refrigerant and labelled for that refrigerant (i.e. special cylinders for the recovery of refrigerant). Cylinders shall be complete with pressure relief valve and associated shut-off valves in good working order. Empty recovery cylinders are evacuated and, if possible, cooled before recovery occurs. The recovery equipment shall be in good working order with a set of instructions concerning the equipment that is at hand and shall be suitable for the recovery of flammable refrigerants. In addition, a set of calibrated weighing scales shall be available and in good working order. Hoses shall be complete with leak-free disconnect couplings and in good condition. Before using the recovery machine, check that it is in satisfactory working order, has been properly maintained and that any associated electrical components are sealed to prevent ignition in the event of a refrigerant release. Consult manufacturer if in doubt. The recovered refrigerant shall be returned to the refrigerant supplier in the correct recovery cylinder, and the relevant Waste Transfer Note arranged. Do not mix refrigerants in recovery units and especially not in cylinders. If compressors or compressor oils are to be removed, ensure that they have been evacuated to an acceptable level to make certain that flammable refrigerant does not remain within the lubricant. The evacuation process shall be carried out prior to returning the compressor to the suppliers. Only electric heating to the compressor body shall be employed to accelerate this process. When oil is drained from a system, it shall be carried out safely.



Exposed to the weather outdoors



Near water



If the power cable wires are frayed or cut



Where small children may be left unattended

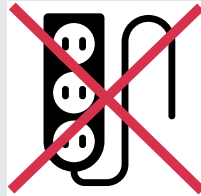

If an extension lead may become overloaded



Where the power cable may be damaged



On a slope or uneven surface



Where there is risk of fire or close to a naked flame



Where it may be damaged by chemicals



Where there is a risk of interference by foreign objects



This product is not made for DIY repair



If there is a risk of water falling on the unit

Specification

Model no.	DCP7W
Colour	White
Power supply	220-240V~, 50Hz
Operating temperature	17-35°C
Thermostat range	17-30°C
Rated Input Power	0.98kW
Cooling Capacity	1.93kW
Dehumidification Capacity	1.93L/hour
Noise Level Minimum (Lo)	51dB(A)
Noise Level Maximum (Hi)	62dB(A)
Air Volume (Lo/Hi)	211/272
Refrigerant	R290
Fan speeds	2
Modes	Cool/Fan/Dry
Timer	24 hours
Dimensions (w x d x h)	329 x 318 x 634mm
Min room size	8m ²
Max room size	14m ²
Weight net	21.7kg
Weight gross	25kg

- The detail of the type and rating of fuses: T; 3,15AL; 250VAC.
- For greater precision, please always refer to the rating label placed on the product.

Parts

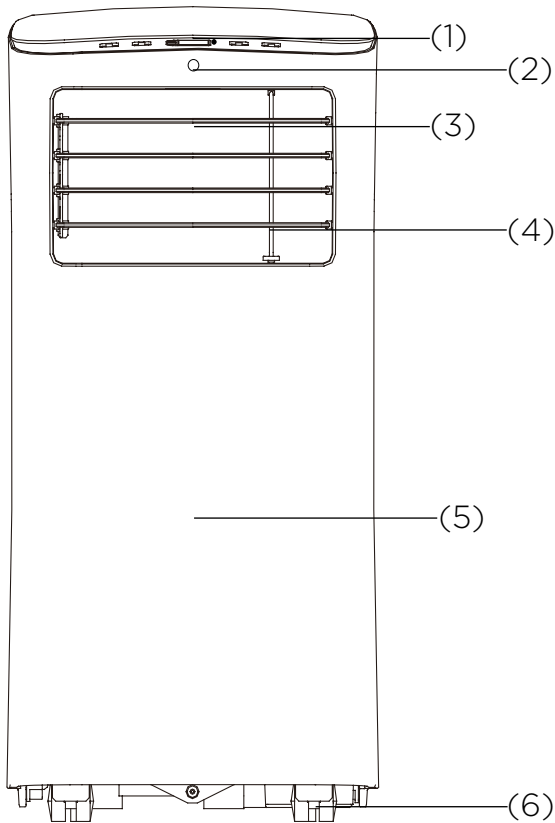

front

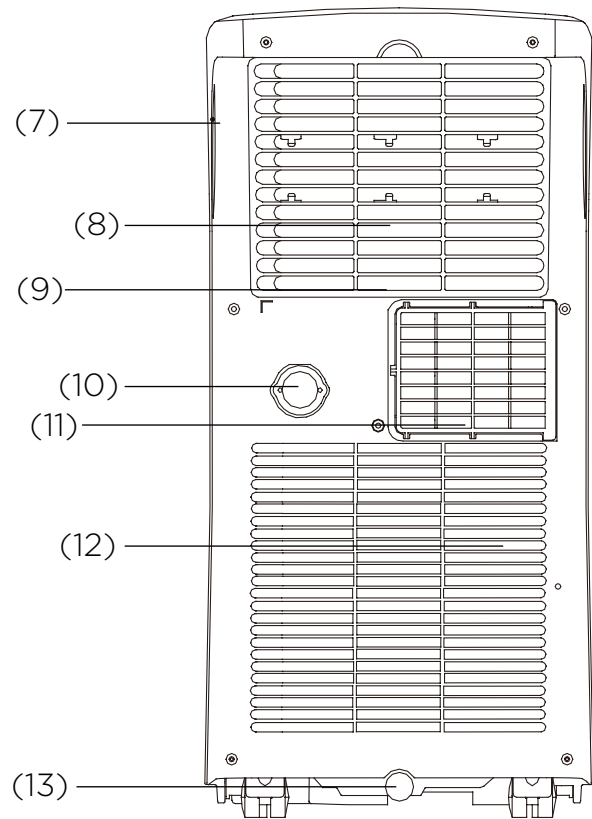

rear

- | | | | |
|-----|--|------|--------------------------|
| (1) | Control panel | (7) | Handle (both sides) |
| (2) | Remote signal receptor | (8) | Air filter |
| (3) | Horizontal manual louvre control lever | (9) | Upper air intake |
| (4) | Vertical manual louvre control lever | (10) | Drain outlet |
| (5) | Panel | (11) | Air outlet |
| (6) | Caster | (12) | Lower air intake |
| | | (13) | Bottom tray drain outlet |

Note:

All the illustrations in the manual are for explanation purposes only. Your unit may be slightly different. The actual shape shall prevail. The unit can be controlled by the unit control panel alone or with the remote controller.

Control Panel

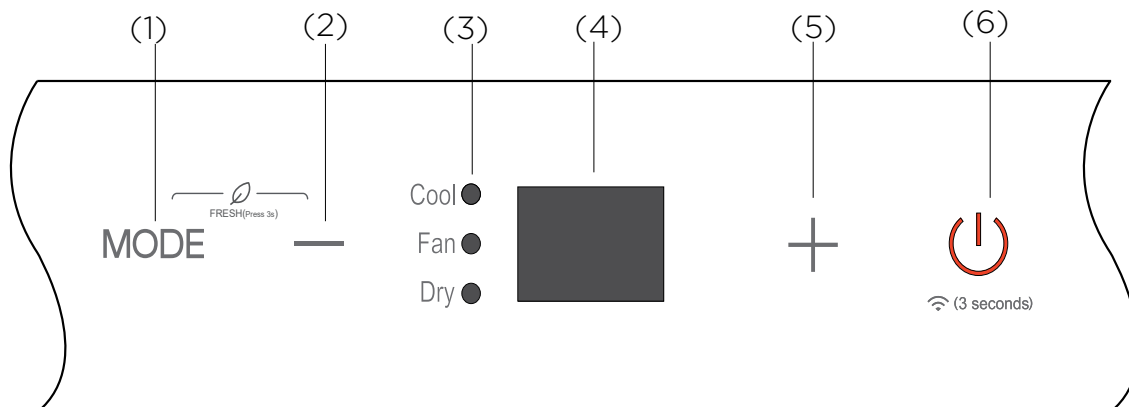

- (1) Mode button
- (2) Temp decrease (-) button
- (3) Indicator light
- (4) LED display screen
- (5) Temp increase (+) button
- (6) Power button

Mode button:

Selects the appropriate operating mode. Each time you press the button, a mode is selected in a sequence that goes from Cool, Fan, Dry, Heat (on some models), and Auto (on some models). The mode indicator light illuminates under the different mode setting.

Temp decrease and increase buttons (- / +):

Used to adjust (increasing/decreasing) temperature settings in 1°C/2°F (or 1°F) increments in a range of 17°C/62°F to 30°C/88°F (or 86°F). NOTE: The control is capable of displaying temperature in Fahrenheit or degrees Celsius. To convert from one to the other, press and hold the Up and Down buttons at the same time for 3 seconds.

Power button:

Switches power on or off.

Note:

The control panel is for explanation purpose only. The control panel of the unit you purchased may be slightly different according to the models. Your machine may not contain some indicators or buttons. The actual shape shall prevail.

LED Display

Shows the set temperature while on Cool, Heat or Auto mode (on some models). While on Dry and Fan modes, it shows the room temperature.

Error codes:

E0 - EEPROM error.

E1 - Room temperature sensor error.

E2 - Evaporator temperature sensor error.

E3 - Condenser temperature sensor error (on some models).

E4 - Display panel communication error.

EC - Refrigerant leakage detection malfunction (on some models).

Protection code:

P1 - Bottom tray is full. Connect the drain hose and drain the collected water away. If protection repeats, call for service.

Note: When one of the above malfunctions occurs, turn off the unit, and check for any obstructions. Restart the unit, if the malfunction is still present, turn off the unit and unplug the power cord. Contact the manufacturer or its service agents or a similar qualified person for service.

Remote Control

USING THE REMOTE CONTROL

1. Open the battery cover of the remote control, and insert 2 x AAA batteries.
2. Please point to the receiver and be within 8m when using the remote control.
3. If the battery voltage is low, please open the battery cover as per the diagram and replace with new batteries (2 x AAA). Then replace the battery cover.

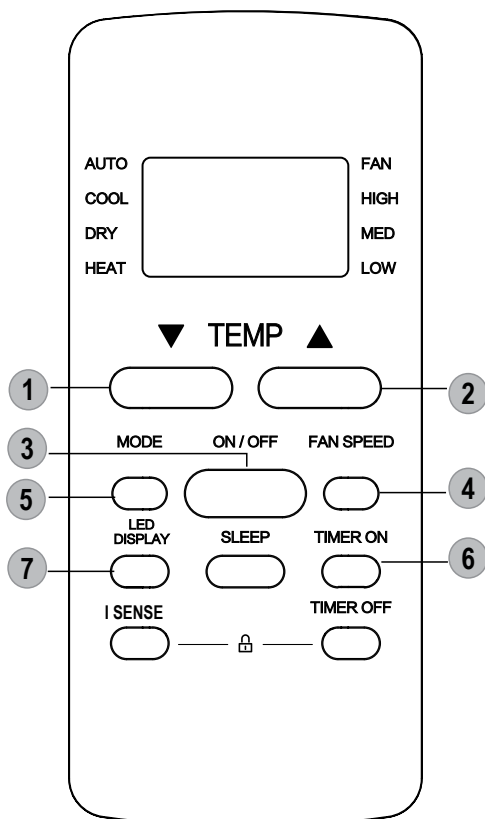





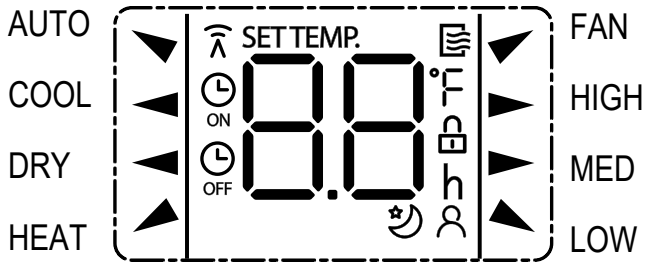



- (1) TEMP: Decreases temperature in 1°C increments
- (2) TEMP: Increases temperature in 1°C increments
- (3) ON/OFF: Turns the unit on or off
- (4) FAN SPEED: Selects fan speed
- (5) MODE: Scrolls through operation modes
- (6) TIMER ON: Sets timer to turn unit on
- (7) LED DISPLAY: Press this to turn on/off the unit display

Remote Control



Mode display

AUTO ▼ COOL ◀ DRY ◀
HEAT ▲ ▼ FAN

-
-  Displayed when data transmitted.
 -  Displayed when remote controller is ON.
-
-  Displayed when TIMER ON time is set
 -  Displayed when TIMER OFF time is set
 -  Shows set temperature or room temperature, or time under TIMER setting
 -  Indicated all the current settings are locked
 -  Displayed when I SENSE feature is activated(some units)
 -  Displayed when SLEEP feature is activated

Fan speed indication

- ▶ HIGH High speed
- ▶ MED Medium speed(some units)
- ▲ LOW Low speed
- NO display Auto fan speed

Note:

All indicators shown in the figure are for the purpose of clear presentation. But during the actual operation, only the relative function signs are shown on the display window.

EXHAUST HOSE INSTALLATION

The exhaust hose and adaptor must be installed or removed in accordance with the usage mode. For COOL, HEAT (heat pump type) or AUTO (on some models) mode the exhaust hose must be installed. For FAN, DRY or HEAT (electrical heat type) the exhaust hose should be removed.

EXHAUSTING HOT AIR

In COOL function the appliance must be placed close to a window or opening so the warm exhaust air can be expelled outside.

CHOOSING THE RIGHT LOCATION

Your installation location should meet the following requirements:

- Make sure that you install your unit on an even surface to minimize noise and vibration.
- The unit must be installed near a sufficient power outlet, and if using a continuous drainage method, then the plug areas should be accessible.
- The unit should be located at least 50cm from the nearest wall to ensure proper air circulation. The horizontal louvre blade should be at least 50cm away from obstacles.
- The exhaust hose can be extended, however it's best to keep it to the minimum length required. Ensure the hose doesn't have any sharp bends, sagging areas or kinks.
- DO NOT cover the Intakes, outlets or remote control signal receptor of the unit, as this could cause damage to the unit.

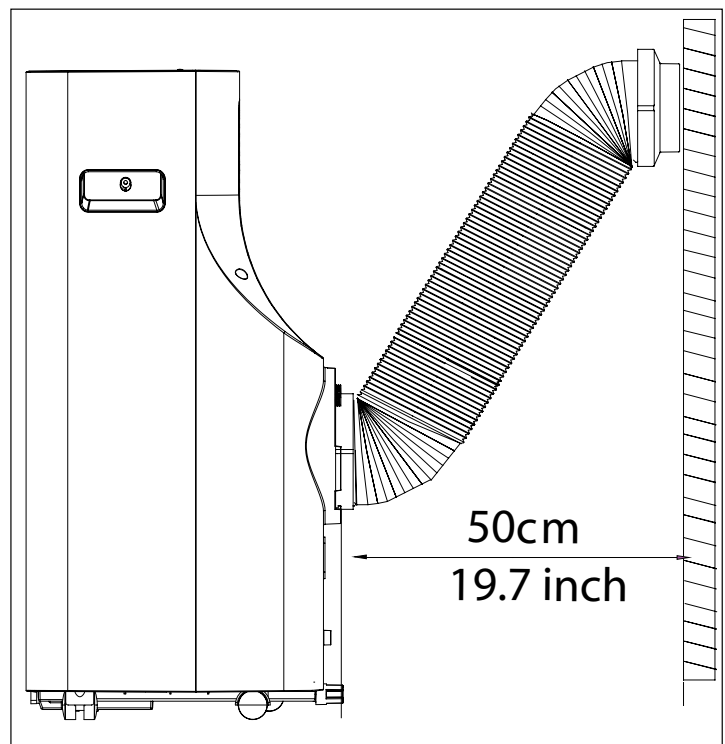
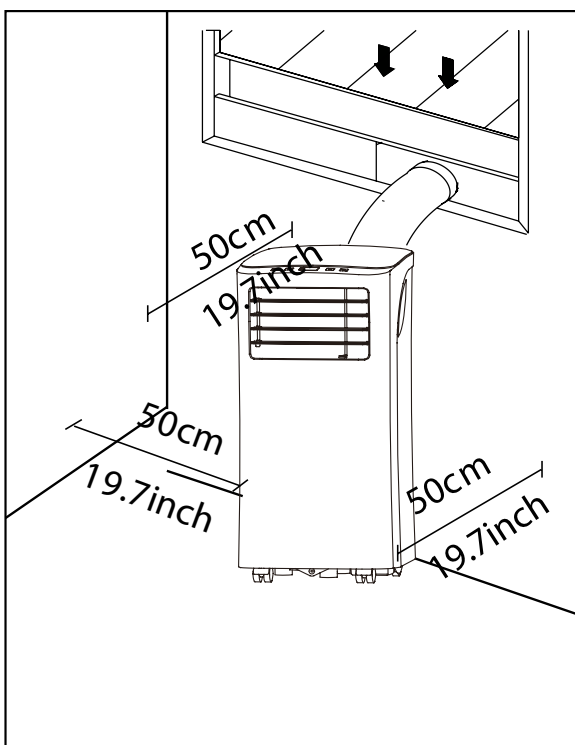

RECOMMENDED INSTALLATION

WINDOW KIT INSTALLATION

The window slider kit has been designed to fit most standard vertical and horizontal window applications, however it may be necessary for you to modify some aspects of the installation procedures for certain types of windows.

Step one: Preparing the exhaust hose assembly

Press the exhaust hose (or extended exhaust hose) into the window slider adaptor (or wall exhaust adaptor) and unit adaptor, clamp automatically by the elastic buckles of the adaptors.

Type window installation:

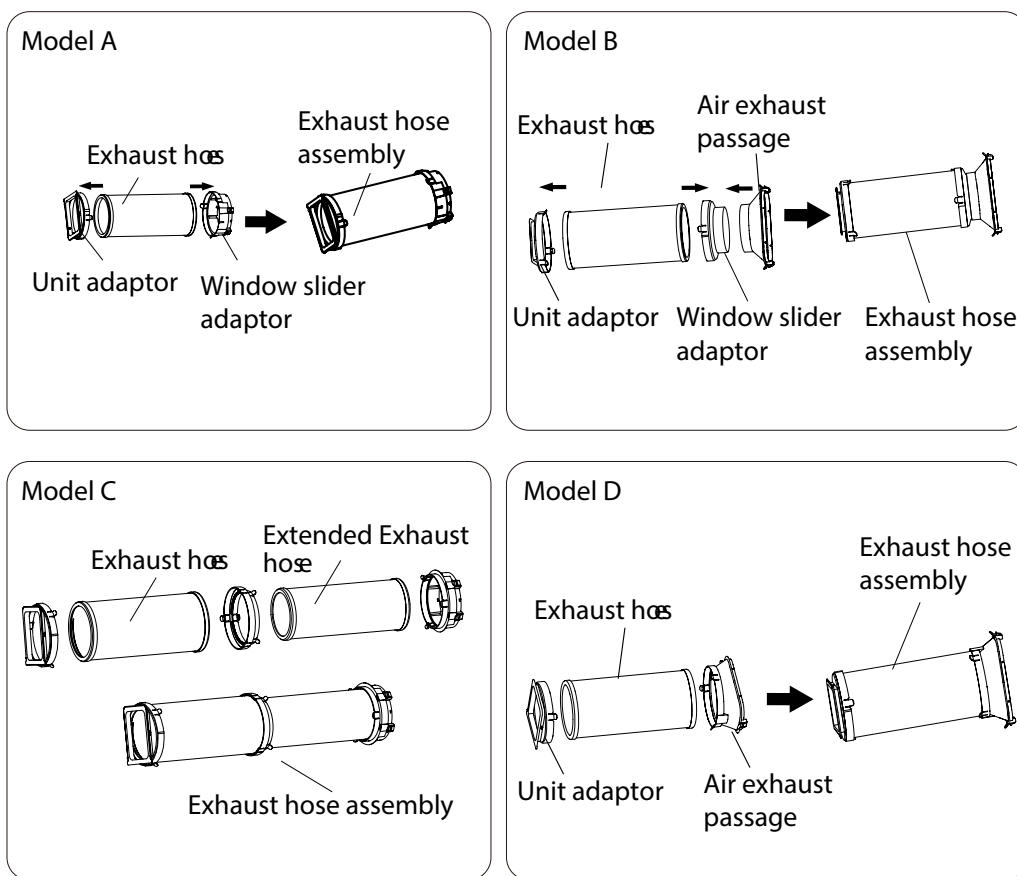

Type wall installation:

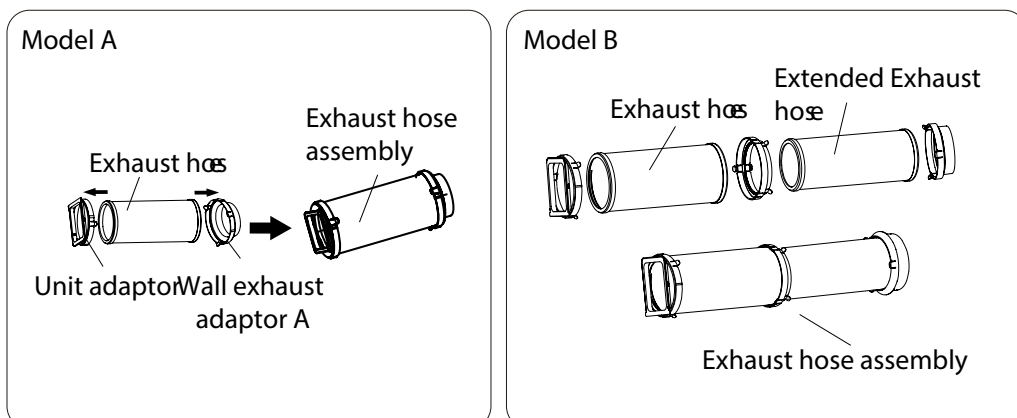

WINDOW KIT INSTALLATION

Step two: Install the exhaust hose assembly to the unit
Push the Exhaust hose into the air outlet opening of the unit along the arrow direction.

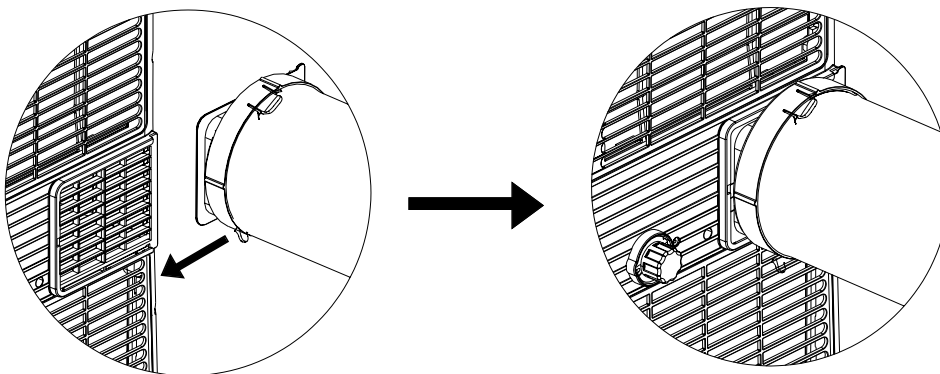

Step three: Preparing the adjustable window slider

1. Choose the window sliders according the size of your window. If the sliders need to be cut to meet the window size, please take extra care to cut it properly.
2. Use bolts to fasten the window sliders once they are adjusted to the correct length.

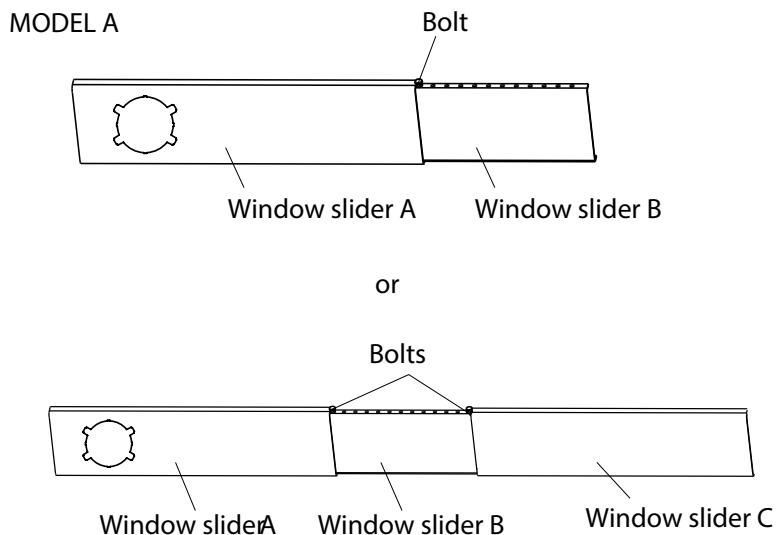

WINDOW KIT INSTALLATION

MODEL B

Before assembly

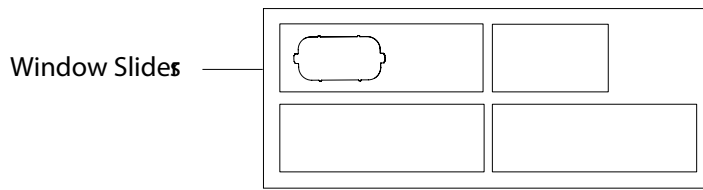

After assembly

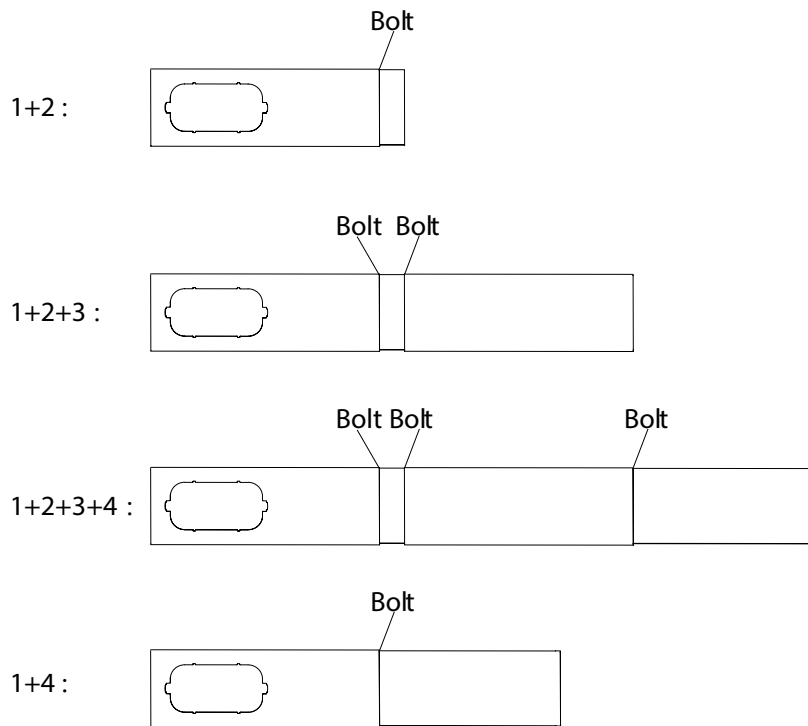

MODEL C

Before assembly

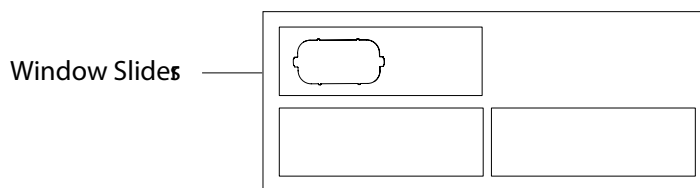

After assembly

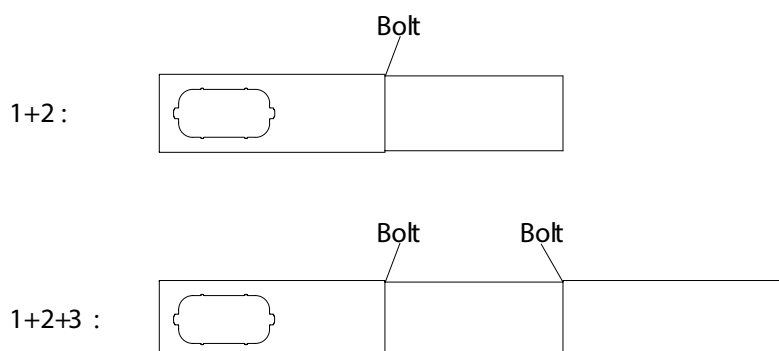

WINDOW KIT INSTALLATION

Note: Once the exhaust hose assembly and adjustable window lider are prepared, choose from one of the following two installation methods.

Type 1: Hung Window or Sliding Window Installation (for some models)

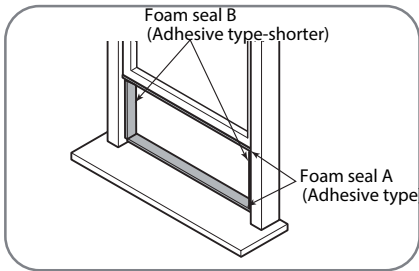

Or

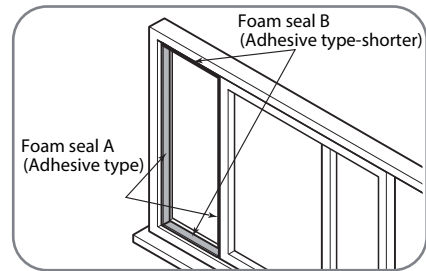

1. Cut the adhesive foam seal A and B strips to the proper lengths, and attach them to the window sash and frame as shown.

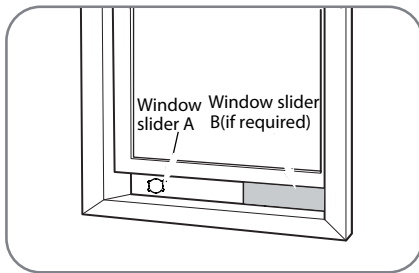

Or

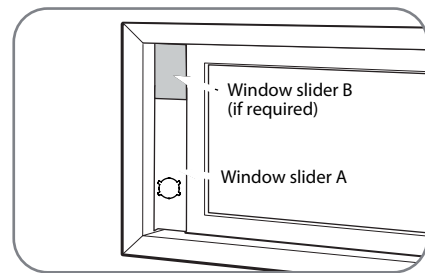

2. Insert the window slider assembly into the window opening.

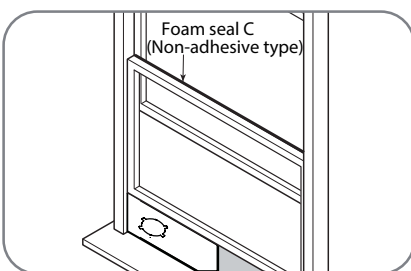

Or

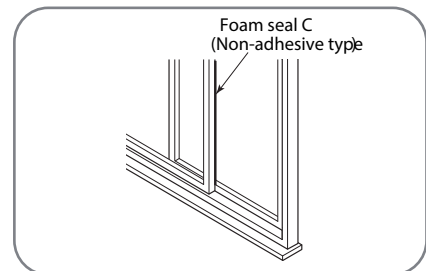

3. Cut the non-adhesive foam seal C strip to match the width(or height) of the window. Insert the seal between the glass and the window frame to prevent air and insects from getting into the room.

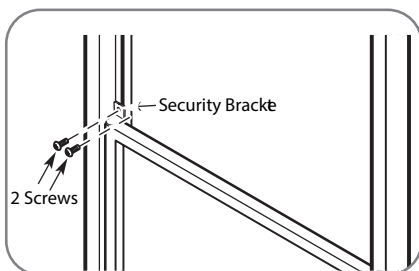

Or

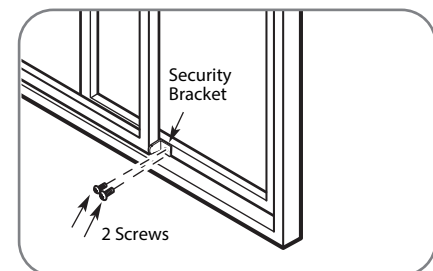

4. If desired, install the security bracket with 2 screws as shown.

Installation

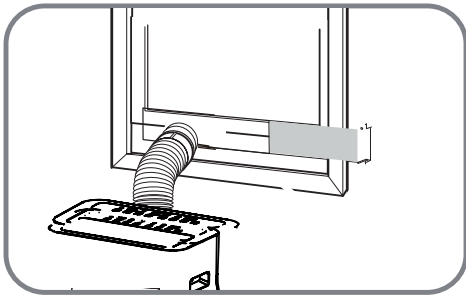

Or

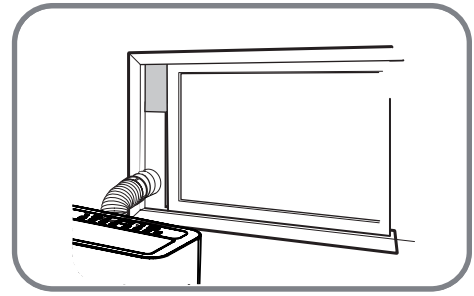

5. Insert the window slider adaptor into the hole of the window slider.

Type 2: Wall Installation (for some models)

1. Cut a 125mm (4.9inch) hole into the wall for wall exhaust adaptor B.
2. Secure the wall exhaust adaptor B to the wall using the four anchors and screws provided in the kit.
3. Connect the exhaust hose assembly (with wall exhaust adaptor A) to the wall exhaust adaptor B.

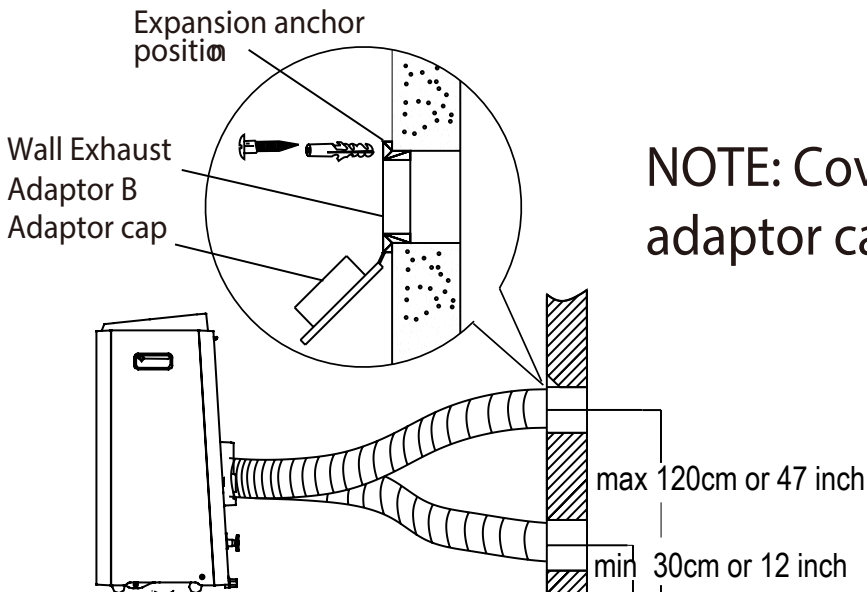

NOTE: Cover the hole using the adaptor cap when not in use.

Note: To ensure proper function, DO NOT overextend or bend the hose. Make sure that there is no obstacle around the air outlet of the exhaust hose (in the range of 500mm) in order for the exhaust system to work correctly. All the illustrations in this manual are for explanation purpose only. Your air conditioner may be slightly different. The actual shape shall prevail.

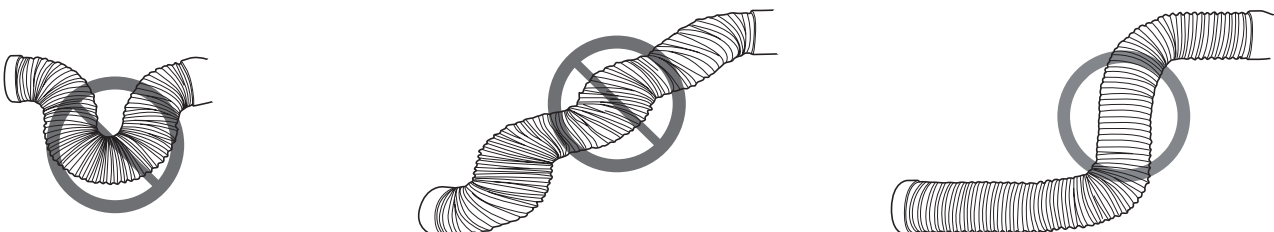















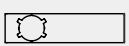



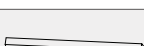

Installation

TOOLS NEEDED

- Medium Philips screwdriver
- Tape measure or ruler
- Knife or scissors
- Saw (optional, to shorten window kit for narrow windows)

ACCESSORIES (not all accessories supplied with all models)

Shape	Name of Accessories	Qty.	Shape	Name of Accessories	Qty.
	Unit Adaptor	1 pc		Security Bracket and 2 Screws	1 set(*)
	Exhaust Hose	1 pc		Drain Hose	1 pc
	Window Slider Adaptor	1 pc(*)		Power Cord Buckle	1 pc
	Window Slider A	1 pc(*)		Bolt	1 pc(*)
	Window Slider B	1 pc(*)		Remote Controller and Battery (only for remote control models)	1 set(*)
	Foam Seal A (Adhesive)	2 pc(*)		Wall Exhaust Adaptor A (only for wall installation models)	1 pc(*)
	Foam Seal B (Adhesive)	2 pc(*)		Wall Exhaust Adaptor B (with cap) (only for wall installation models)	1 pc(*)
	Foam Seal C (Non-adhesive)	1 pc(*)		Screw and anchor (only for wall installation models)	4 set(*)
	Drain Hose Adaptor (only for heat pump mode)	1 pc(*)		Extended Exhaust Hose	1 pc(*)
	Exhaust Hose Adaptor	1 pc(*)		Air exhaust passage	1 pc(*)
	Window Sliders	1 set(*)			

Operating Instructions

COOL operation

- Press the "MODE" button until the "COOL" indicator light comes on.
- Press the ADJUST buttons "+" or "-" to select your desired room temperature. The temperature can be set within a range of 17°C~30°C/62°F~88°F(or 86°F).
- Press the "FAN SPEED" button to choose the fan speed.

DRY operation

- Press the "MODE" button until the "DRY" indicator light comes on.
- The fan speed or the temperature cannot be adjusted. The fan motor operates at LOW speed. note: Keep windows and doors closed for the best dehumidifying effect. Do not put the duct to window.

FAN operation

- Press the "MODE" button until the "FAN " indicator light comes on.
- Press the "FAN SPEED" button on the remote controller to choose the fan speed. The temperature can not be adjusted.
- Do not put the duct to window.

AUTO operation (on some models)

- When you set the air conditioner in AUTO mode, it will automatically select cooling, heating (cooling only models without), or fan only operation depending on what temperature you have selected and the room temperature.
- The air conditioner will control room temperature automatically round the temperature point set by you.
- Under AUTO mode, you can not select the fan speed.

Note: Under AUTO mode, both the AUTO mode and the actual operation mode indicator lights illuminate for some models.

HEAT operation (cooling only models without)

- Press the "MODE" button until the "HEAT" indicator light comes on.
- Press the ADJUST buttons "+" or " - " to select your desired room temperature. The temperature can be set within a range of 17°C~30°C/62°F~88°F (or 86°F).
- Press the "FAN SPEED" button on the remote controller to choose the fan speed.

Wireless operation (on some models)

Used to initiate the wireless connection mode. For the first time to use wireless function, press the POWER button for 3 seconds to initiate the wireless connection mode . The LED DISPLAY shows 'AP' to indicate you can set wireless connection. If connection (router) is successful within 8 minutes, the unit will exit wireless connection mode automatically and the wireless indicator illuminates. If connection is failure within 8 minutes, the unit exits wireless connection mode automatically. After Wireless connection is successful, for some models you can press MODE and UP (+) buttons at the same time for 3 seconds to turn off Wireless function and the LED DISPLAY shows 'OF' for 3 seconds, press MODE button and UP (+) to turn on Wireless function and the LED DISPLAY shows 'On' for 3 seconds.

Note: When you restart the wireless function, it may take a period of time to connect to the network automatically.

Operating Instructions

Constant Fan button (On some models)

In Cooling or Dry mode, press the button for 3 seconds to turn on or off the constant fan function. When the function is turned on, the constant fan light will illuminate, identifying the fan continuous run for cooling. When the function is turned off, the constant fan light will go out, identifying the fan cycle run with compressor stop.

FRESH operation (on some models)

Press MODE and DOWN (-) buttons at the same time for 3 seconds to initiate FRESH feature and the FRESH light illuminates on some models, the LED DISPLAY shows 'On' for 3 seconds. The ion generator is energized and will help to purify the air inside. Press it for 3 seconds again to stop the FRESH feature and the FRESH light turn dark on some models, the LED DISPLAY shows 'OF' for 3 seconds for some units.

SLEEP/ECO operation

This feature can ONLY be activated from the remote control. To activate SLEEP feature, the set temperature will increase (cooling) or decrease (heating) by 1°C/2°F (or 1°F) in 30 minutes. The set temperature will then increase (cooling) or decrease (heating) by another 1°C /2°F (or 1°F) after an additional 30 minutes. This new temperature will be maintained for 7 hours before it returns to the originally selected temperature. This ends the Sleep mode and the unit will continue to operate as originally programmed.

Note: This feature is unavailable under FAN or DRY mode.

FOLLOW ME/TEMP SENSING feature (on some models)

This feature can ONLY be activated from the remote control. The remote control serves as a remote thermostat allowing for the precise temperature control at its location. To activate the Follow Me/Temp Sensing feature, point the remote control towards the unit and press the Follow Me/Temp Sensing button. The remote control will send this signal to the air conditioner until the Follow Me/Temp Sensing button is pressed again. If the unit does not receive the Follow Me/Temp Sensing signal during any 7 minute interval, the unit will exit the Follow Me/Temp Sensing mode.

Note: This feature is unavailable under FAN or DRY mode.

AUTO-RESTART

If the unit shuts off unexpectedly due to a power cut, it will restart with the previous function setting automatically when the power resumes.

AIR FLOW DIRECTION ADJUSTMENT

Adjust the air flow direction manually:

- The louver can be set to the desired position manually.
- Do not place any heavy objects or other loads on the louver, doing so will cause damage to the unit.
- Ensure the louver is fully opened under heating operation.
- Keep the louver fully opened during operation.

WAIT 3 MINUTES BEFORE RESUMING OPERATION

After the unit has stopped, it can not be restarted for at least 3 minutes. This is to protect the unit. Operation will automatically start after 3 minutes.

Operating Instructions

POWER MANAGEMENT feature (On some models)

Under cooling operation, when the ambient temperature is lower than the setting temperature for a period of time, the unit will automatically operate the power management feature. The compressor and fan motor will stop. When the ambient temperature is higher than the setting temperature, the unit will automatically quit the power management feature. The compressor and (or) fan motor will run.

Water Drainage

WATER DRAINAGE

· During dehumidifying modes, remove the drain plug from the back of the unit, install the drain connector (5/8" universal female mender) with 3/4" hose (purchased separately). For the models without drain connector, just attach the drain hose to the hole. Place the open end of the hose directly over a suitable drainage area.

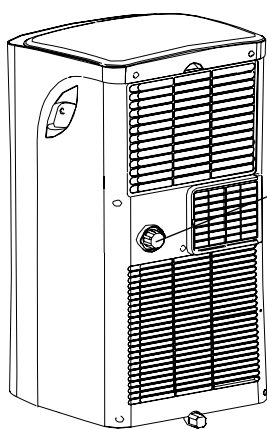

Remove the
drain plug

Continuous
drain hose

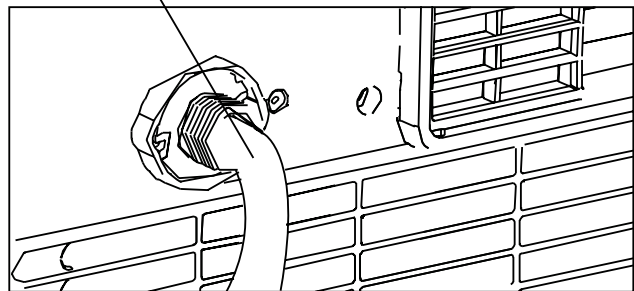

Note: Make sure the hose is secure so there are no leaks. Direct the hose toward the drain, making sure that there are no kinks that will stop the water flowing. Place the end of the hose into the drain and make sure the end of the hose is down to let the water flow smoothly. When the continuous drain hose is not used, ensure that the drain plug and knob are installed firmly to prevent leakage.

During heating pump mode, remove the lower drain plug from the back of the unit, install the drain connector (5/8" universal female mender) with 3/4" hose (locally purchased). Carefully move the unit to a drain location, and let the water drain away. Note: Make sure the drain hose is lower than the bottom tray drain outlet.

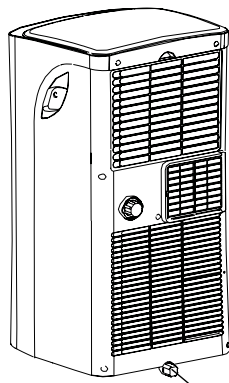

Remove the drain plug

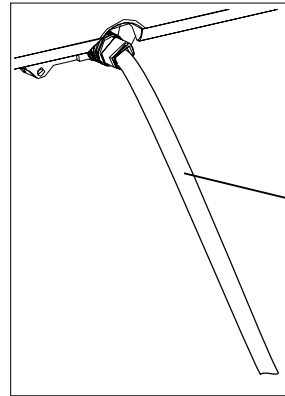

Continuous
drain hose

When the water level of the bottom tray reaches a predetermined level, the unit beeps 8 times, the digital display area shows "P1". At this time the air conditioning/dehumidification process will immediately stop. However, the fan motor will continue to operate (this is normal). Carefully move the unit to a drain location, remove the bottom drain plug and let the water drain away. Reinstall the bottom drain plug and restart the machine until the "P1" symbol disappears. If the error repeats, call for service.

Note: Be sure to reinstall the bottom drain plug firmly to prevent leakage before using the unit.

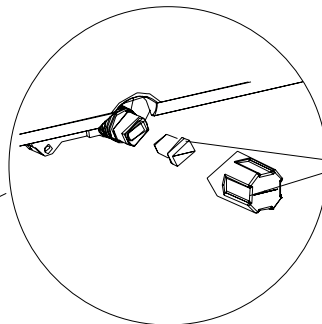
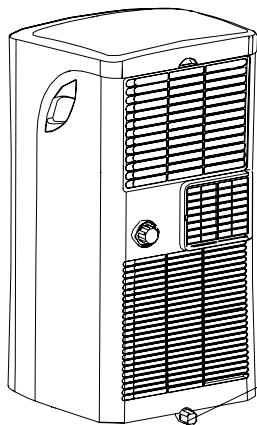

Bottom drain
plug

SAFETY PRECAUTIONS

- Always unplug the unit before cleaning or servicing.
- DO NOT use flammable liquids or chemicals to clean the unit.
- DO NOT wash the unit under running water. Doing so causes electrical danger.
- DO NOT operate the machine if the power supply was damaged during cleaning. A damaged power cord must be replaced with a new cord from the manufacturer.

AIR FILTERS

CAUTION: Never operate the unit without a filter in place.

- Be sure to clean the air filter every 2 weeks for optimal performance.
- The water collection tray should be drained immediately after P1 error occurs, and before storage to prevent mould.
- In households with animals, you will have to periodically wipe down the grill to prevent blocked airflow due to animal hair.

Following the below diagram, remove the filter from the back of the unit.

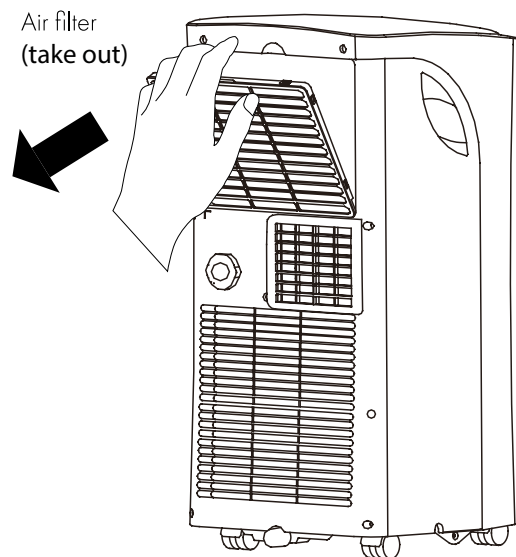

Remove the air filter

Outside Cabinet

1. Remove any dust build up with a soft brush.
2. Wipe the surface of the unit with a soft damp cloth. Mild detergent can be used for any stubborn marks.

Do not use abrasive sponges, scouring pads, or a stiff brush to clean the unit.

IMPORTANT

The control panel and other parts must not come into contact with water or any other liquids.

Maintenance

Storage

If not using the unit for an extended period of time, after cleaning please:

- Turn the unit OFF, unplug and take care of the mains lead & plug.
- Drain any water from the unit according to the instructions in the following sections.
- Run the appliance on FAN MODE for 12 hours in a warm room to dry out and prevent mould.
- Clean the air filter as described on the previous page.
- Remove the batteries from the remote control.
- Cover the unit and store it upright in a location where it will not receive direct sunlight.

Note: Prolonged exposure to direct sunlight will discolour the enclosure.

If the unit fails to operate efficiently, is broken or other problems arise, unplug and do not operate. Ask for advice by calling your local after sales service agent or the Customer Care Centre on 1300 556 816 (AU) / 0800 666 2824 (NZ).

Warranty

Please refer to the warranty card in the box for warranty information. For any troubleshooting advice, please contact the relative Customer Care Centre below.

Glen Dimplex Australia Pty Ltd
8 Lakeview Drive,
Scoresby 3179, Victoria
Australia
Ph: 1300 556 816

Glen Dimplex New Zealand Ltd
38 Harris Road, East Tamaki,
Auckland 2013
New Zealand
Ph: 0800 666 2824

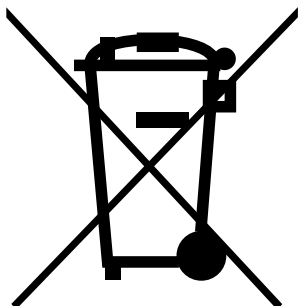

Recycling: Do not dispose of electrical appliances as unsorted municipal waste. Use separate collection facilities. Contact your local government for information regarding the collection systems available. If electrical appliances are disposed of in landfills or dumps, hazardous substances can leak into the ground water, polluting the food chain and damaging health and well-being.



Customer Care: 1300 556 816
customer.care@glendimplex.com.au
www.dimplex.com.au

Supplied by Glen Dimplex Australia
8 Lakeview Drive, Scoresby, Victoria, 3179

© Glen Dimplex Australia. All rights reserved. Material contained in this publication may not be reproduced in whole or in part, without prior permission in writing of Glen Dimplex Australia.